

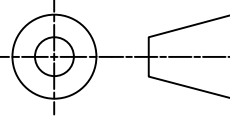

NOTES:

- 1) ALUMINUM FRAME
- 2) FINISH: WHITE POWDER COATED
- 3) INCLUDED:
 - 3 mm, WHITE NET
 - 2 WEIGHTS
 - CARRY BAG
- 4) ASSEMBLED WEIGHT: 118 LBS.

	THIRD ANGLE PROJECTION		140 Pacific Drive Quakertown, Pa. 18951
DIMENSIONS ARE IN INCHES UNLESS OTHERWISE SPECIFIED		Approved By: Willenbecher Date: 9/8/2016	Drawing #: WC-240AS
This item is the confidential property of KWIK GOAL LTD. Reproduction or duplication without the express written consent of KWIK GOAL LTD. is strictly forbidden.		Drawn By: cspeck Date: 8/17/2016	Desc: NXT TRAINING FRAME 8' X 24'
		Sheet: 1 of 4 Revision #: 3	
		Cad File: WC-240AS.idw	

OVERHEAD VIEW

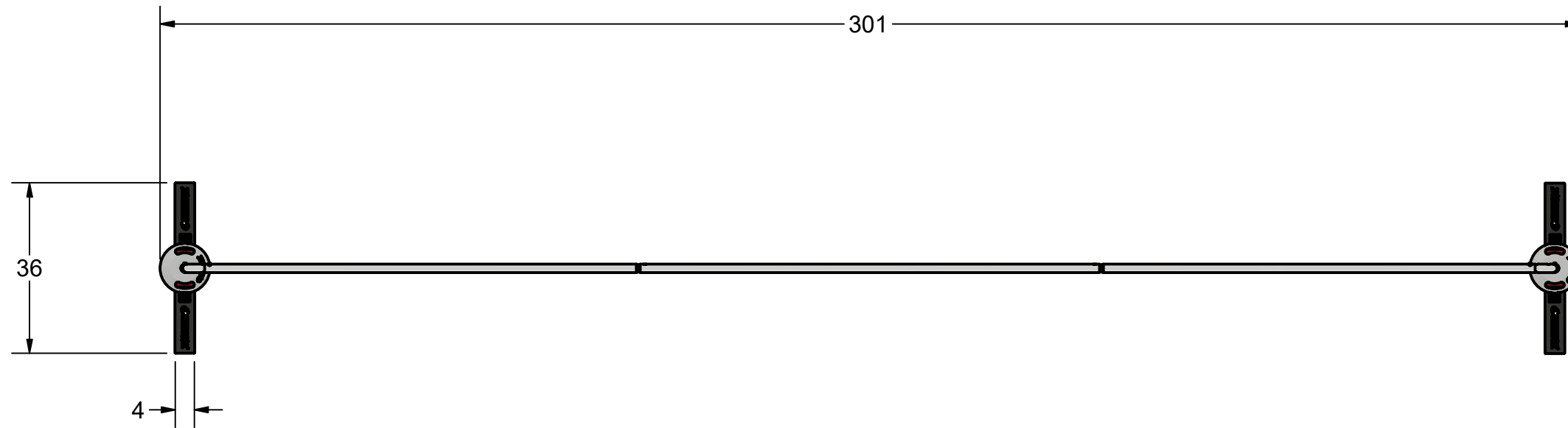

NOTES:

- 1) DIMENSIONS ARE FOR PLANNING PURPOSES. INSTALLATION MUST BE IN ACCORDANCE WITH INSTALLATION INSTRUCTIONS.

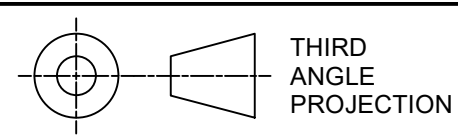
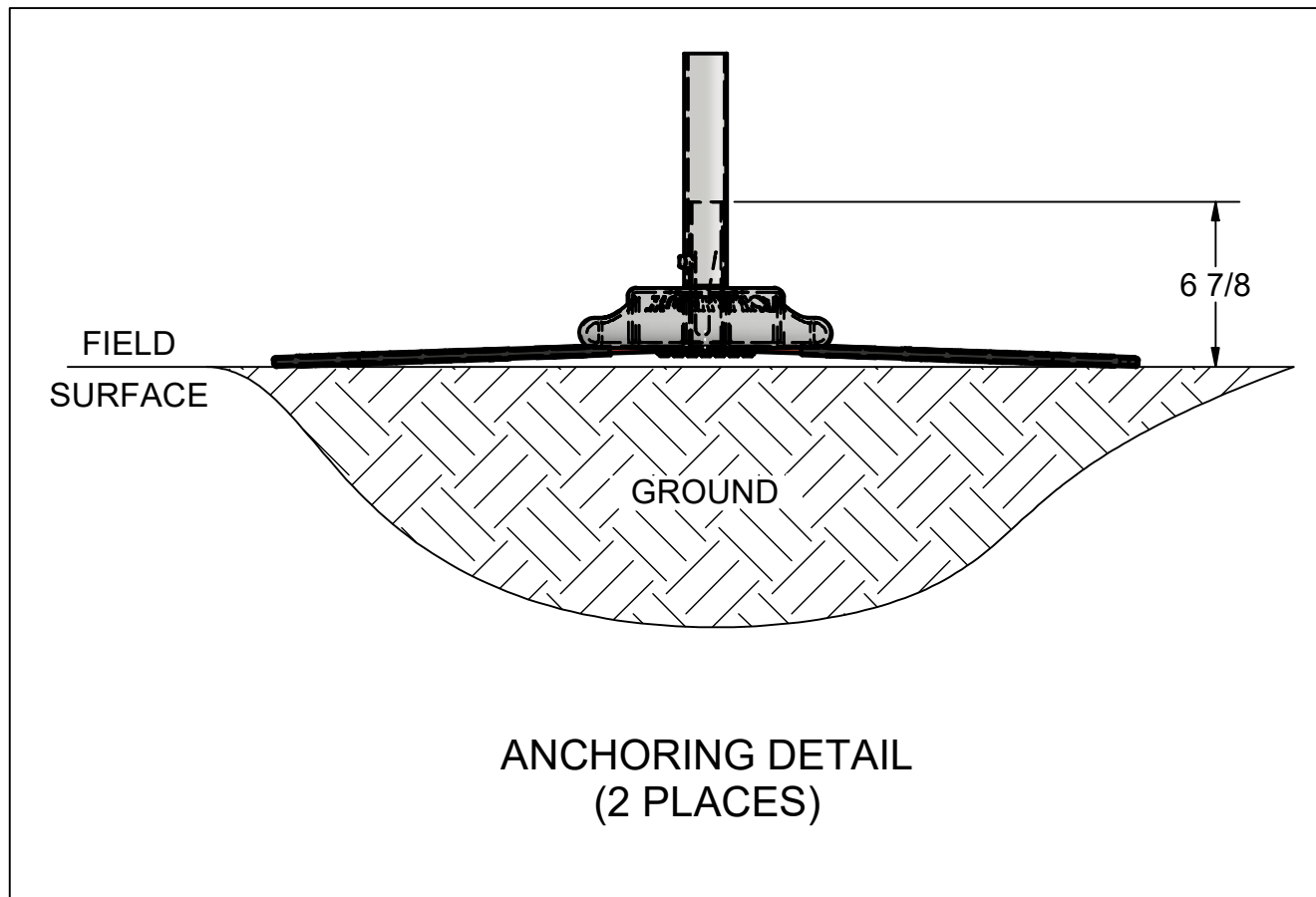

THIRD ANGLE PROJECTION

KWIKGOAL® 140 Pacific Drive
Quakertown, Pa. 18951

DIMENSIONS ARE IN INCHES UNLESS OTHERWISE SPECIFIED

Approved By: Willenbecher
Date: 9/8/2016

Drawing #: WC-240AS

This item is the **confidential** property of **KWIK GOAL LTD.** Reproduction or duplication **without** the express written consent of **KWIK GOAL LTD.** is **strictly forbidden.**

Drawn By: cspeck
Date: 8/17/2016
Sheet: 2 of 4
Revision #: 3
Cad File: WC-240AS.idw

Desc: NXT TRAINING FRAME 8' X 24'

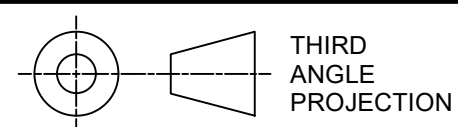
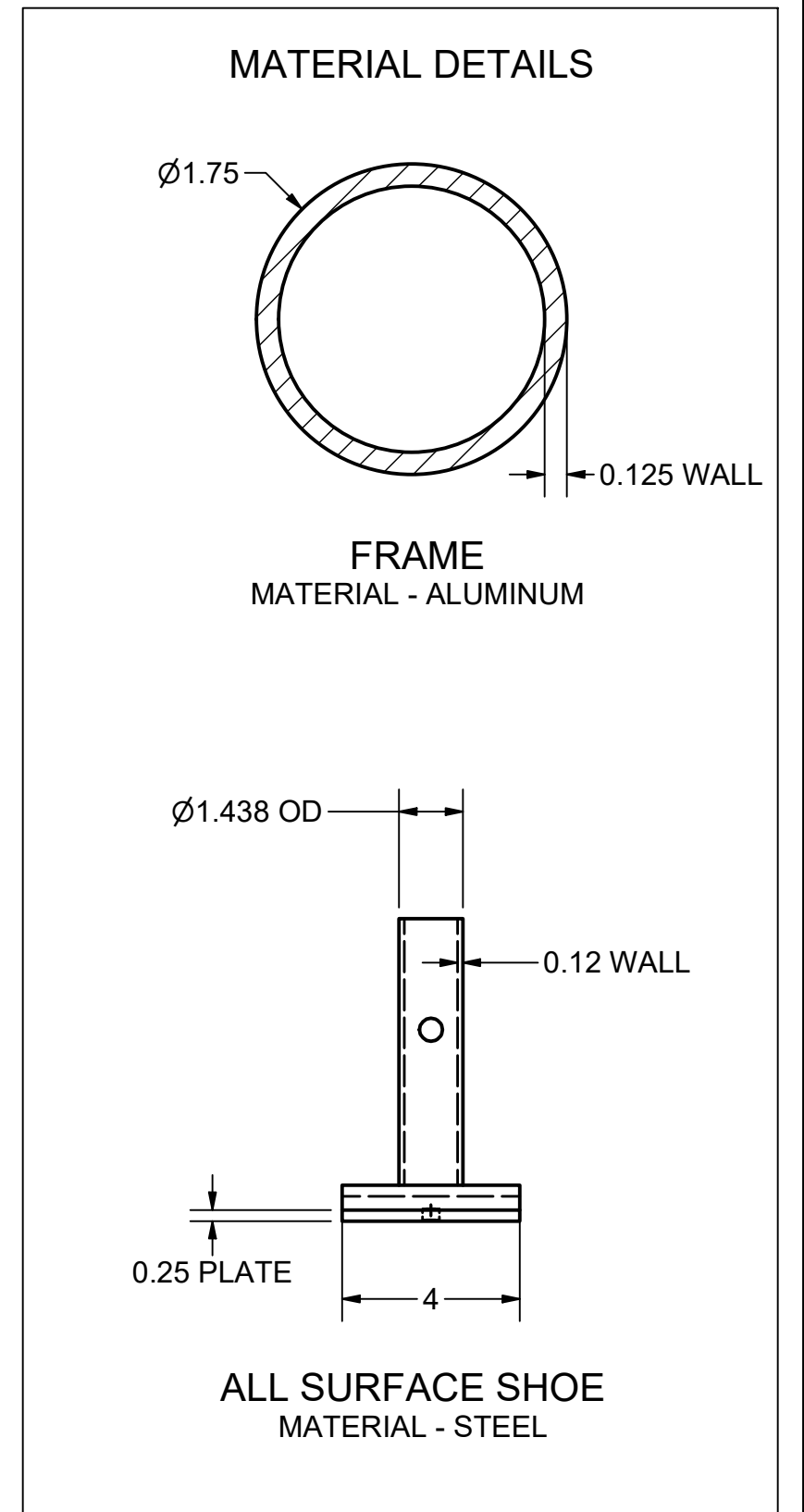
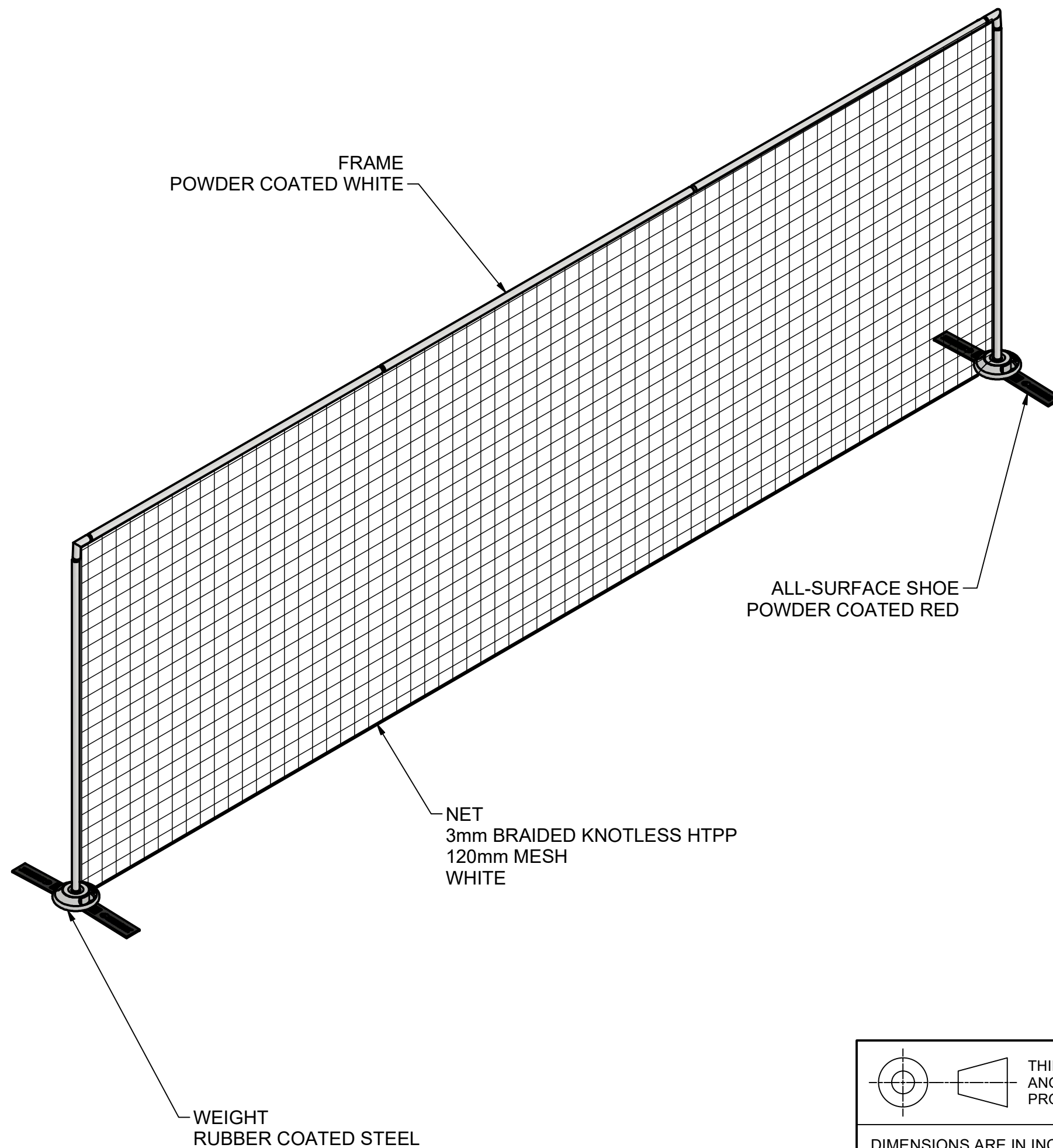

KWIKGOAL® 140 Pacific Drive
Quakertown,
Pa. 18951

DIMENSIONS ARE IN INCHES
UNLESS OTHERWISE SPECIFIED

Approved By: Willenbecher
Date: 9/8/2016

Drawing #:
WC-240AS

This item is the **confidential**
property of **KWIK GOAL LTD.**
Reproduction or duplication
without the express written
consent of **KWIK GOAL LTD.**
is **strictly forbidden.**

Drawn By: cspeck
Date: 8/17/2016
Sheet: 3 of 4
Revision #: 3
Cad File: WC-240AS.idw

Desc:
NXT TRAINING FRAME
8' X 24'

PARTS LIST		
PART#	QTY	DESCRIPTION
UZ129	2	ALL-SURFACE SHOE, NXT TRAINING FRAME
UZ1557	2	POST
UZ1549	2	CROSSBAR SWAGE
UZ1757	2	CROSSBAR CORNER 93°
WZ1003	1	CROSSBAR
VZ760	2	BASE WEIGHT
WC-24GAW	1	NET, NXT TRAINING FRAME

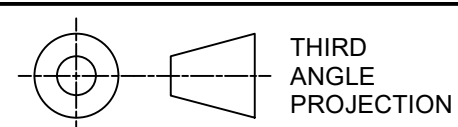
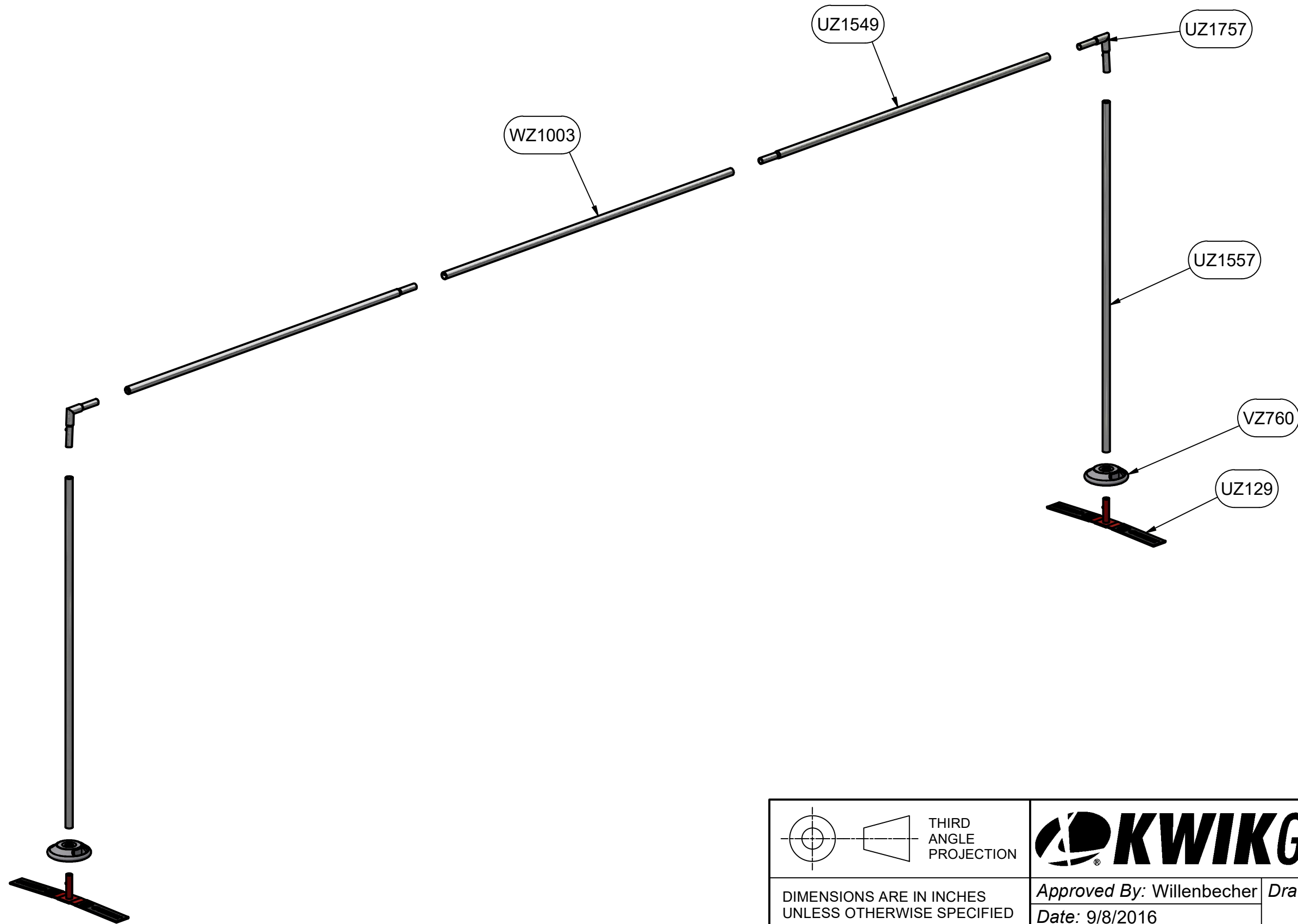

THIRD
ANGLE
PROJECTION

KWIKGOAL® 140 Pacific Drive
Quakertown,
Pa. 18951

DIMENSIONS ARE IN INCHES
UNLESS OTHERWISE SPECIFIED

Approved By: Willenbecher
Date: 9/8/2016

Drawing #:
WC-240AS

This item is the **confidential**
property of **KWIK GOAL LTD.**
Reproduction or duplication
without the express written
consent of **KWIK GOAL LTD.**
is **strictly forbidden.**

Drawn By: cspeck
Date: 8/17/2016
Sheet: 4 of 4
Revision #: 3
Cad File: WC-240AS.idw

Desc:
NXT TRAINING FRAME
8' X 24'